















WZ 4020

-  Направляющие колонки прессовой посадки
-  Führungssäulen zum Einpressen
-  Inperszuilen
-  Colonnes de guidage à ajustement serré

Мат.: 1.5732 / 61 - 63 HRC

-  Направляющие колонки подходят для втулок
-  Führungssäule passend zu Buchsen
-  Geleidingszuil passend bij de busen
-  Colonnes de guidage adaptées aux douilles

**Wz 4026, Wz 4030, Wz 4031, Wz 4032, Wz 4039,
Wz 4040, Wz 4041, Wz 4050, Wz 4051, Wz 4053,
Wz 4055, Wz 4057, Wz 4058, Wz 4068, Wz 4153,
Wz 4157, Wz 4158, Wz 9040, Wz 9050.**

-  Подходят для сепараторов
-  Passend zu Kugelkäfigen
-  Passend bij kogelkooien
-  Adaptées aux cages à billes

Wz 4024 M, Wz 4025

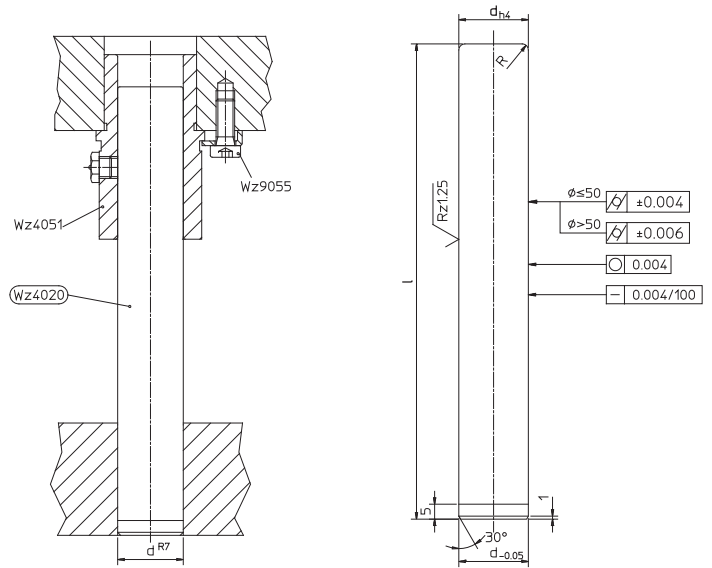

 = Комплект поставки | Lieferumfang | Leveringsomvang | Inclu

d	l											
	120	130	140	150	160	170	180	190	200	210	220	230
18/19												
24/25												
30/32												
40/42												
50/52												
63												
80												
d	l											
	240	250	260	270	280	300	320	350	360	400	450	500
18/19												
24/25												
30/32												
40/42												
50/52												
63												
80												

Пример заказа | Bestellbeispiel | Bestelvoorbeeld | Exemple de commande : (Артикул + d + l) **WZ 4020 18 120**